

チラシDEエコバッグ作り方

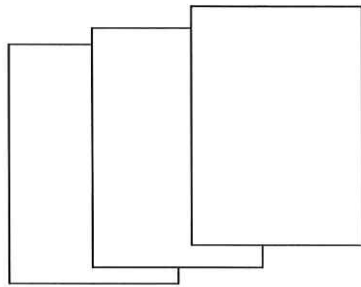

のりしろ1cm位

用意するもの
 チラシA4サイズ3枚
 (※本体用=2枚 取っ手用=1枚)
 のり・カッター
 新聞紙等(下敷きにするもの)

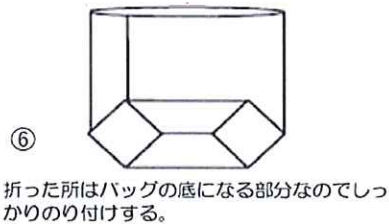
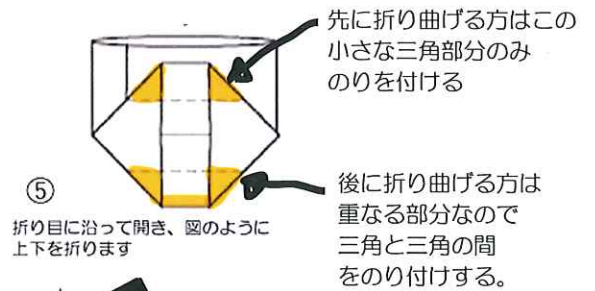
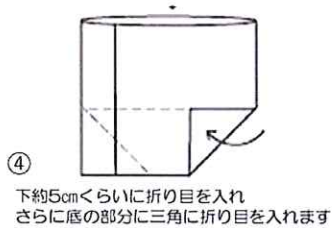
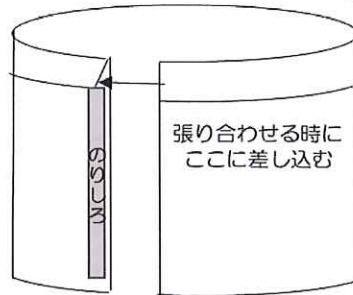
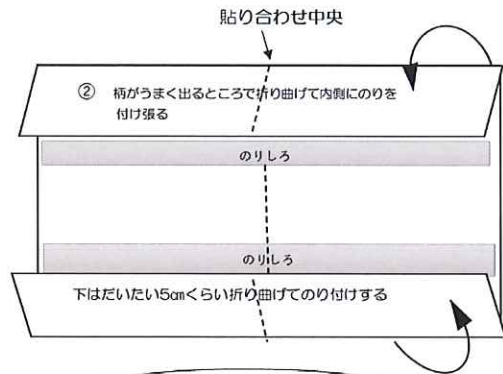

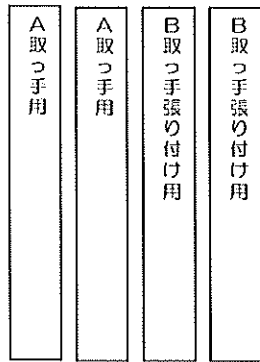
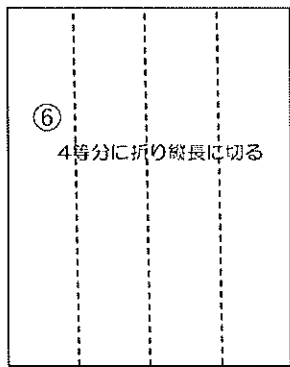

Aを縦半分に折りのりで張り合わせるのを3回繰り返す

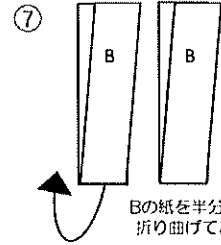
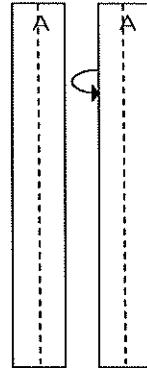

Bの紙を半分から折り曲げておく

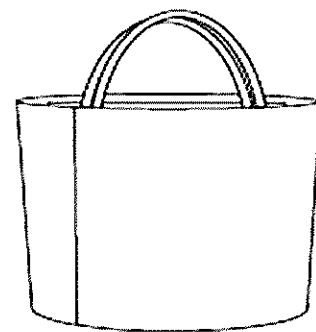
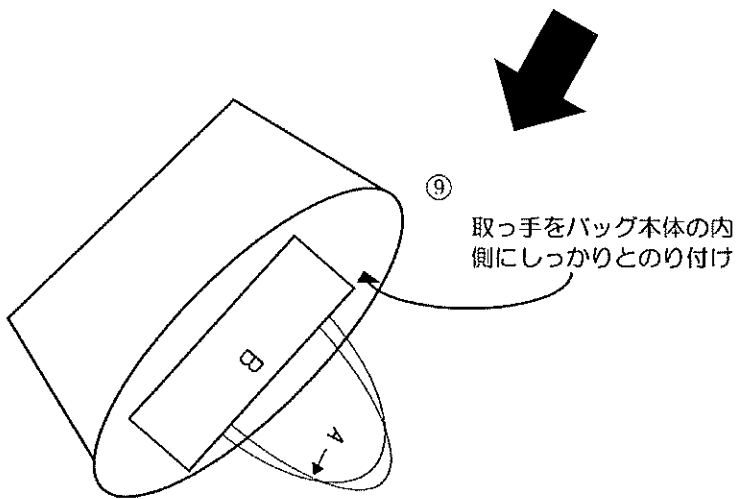
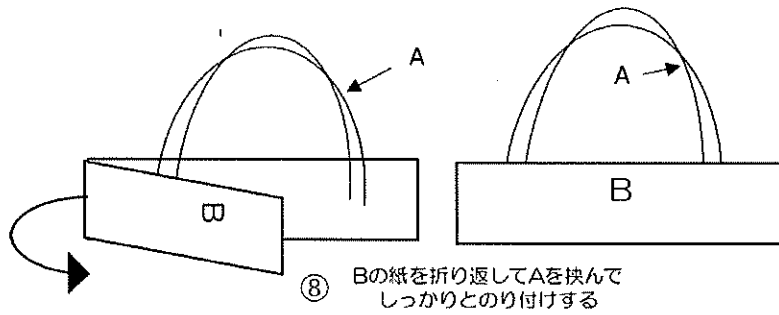

⑩ 出来上がり♪